



Hutchison Hayes Separation Inc.

HH 1448 Standard



The HH 1448 Standard is a configuration of a drive system for a Decanting centrifuge. This configuration is the most basic of many available configurations. The Centrifuge bowl is driven by a main drive motor and the conveyor is driven through a planetary gear box with a simple torque arm setup.

The torque arm is torque limiting device to protect both gearbox and conveyor against mechanical overload. The conveyor speed is simply the Bowl RPM reduced by the gearbox ratio.

The HH 1448 Standard can be delivered in different variants, explosion proof for hazardous areas, sanitary for Food applications or in a normal Nema 4 execution.

Main drive motor is setup with a sheave that allows simple selection of speeds, by moving the v-belt assembly. Alternatively the main drive can be set-up with VFD starter and electric selection of main drive speeds

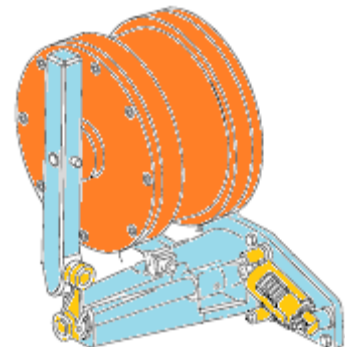

Hutchison Hayes Separation Inc.
3520 East Sam Houston Beltway N.
Houston, Texas 77015, USA
Phone 713 455 9600

www.hutchisonhayes.com
P.O.Box 2965
Houston, Texas 77252, USA
Fax 713 455 7753



Hutchison Hayes Separation Inc.

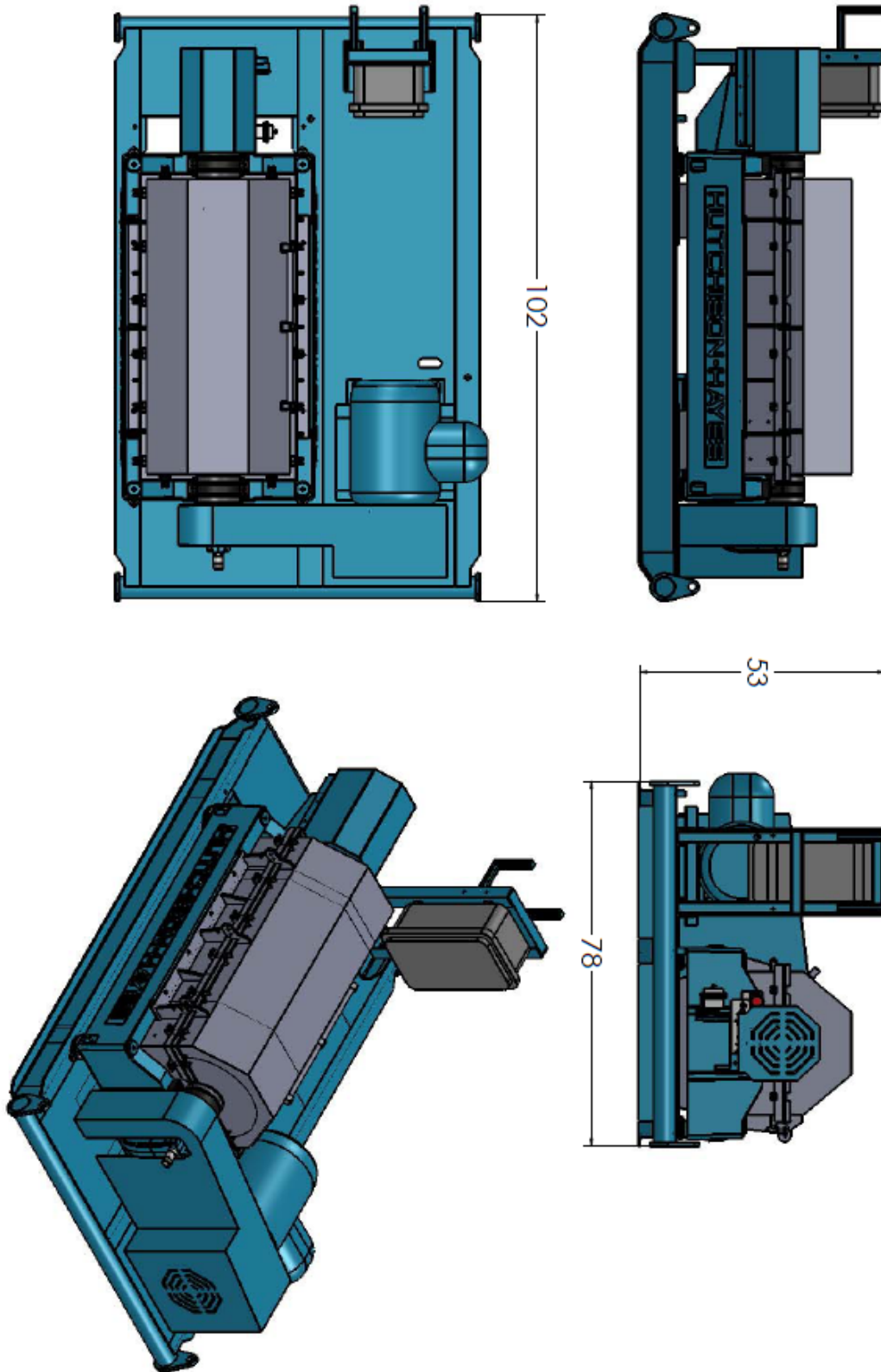

Hutchison Hayes Separation Inc.
3520 East Sam Houston Beltway N.
Houston, Texas 77015, USA
Phone 713 455 9600

www.hutchisonhayes.com
P.O.Box 2965
Houston, Texas 77252, USA
Fax 713 455 7753