

Hutchison-Hayes Separators, Inc.

Model 510 Separator Parts List With Diagrams

P.O. Box 2965 ♦ Houston, Texas 77252
3520 East Belt ♦ Houston, Texas 77015
(713) 455-9600 ♦ Fax (713) 455-7753

MAIN ASSEMBLY

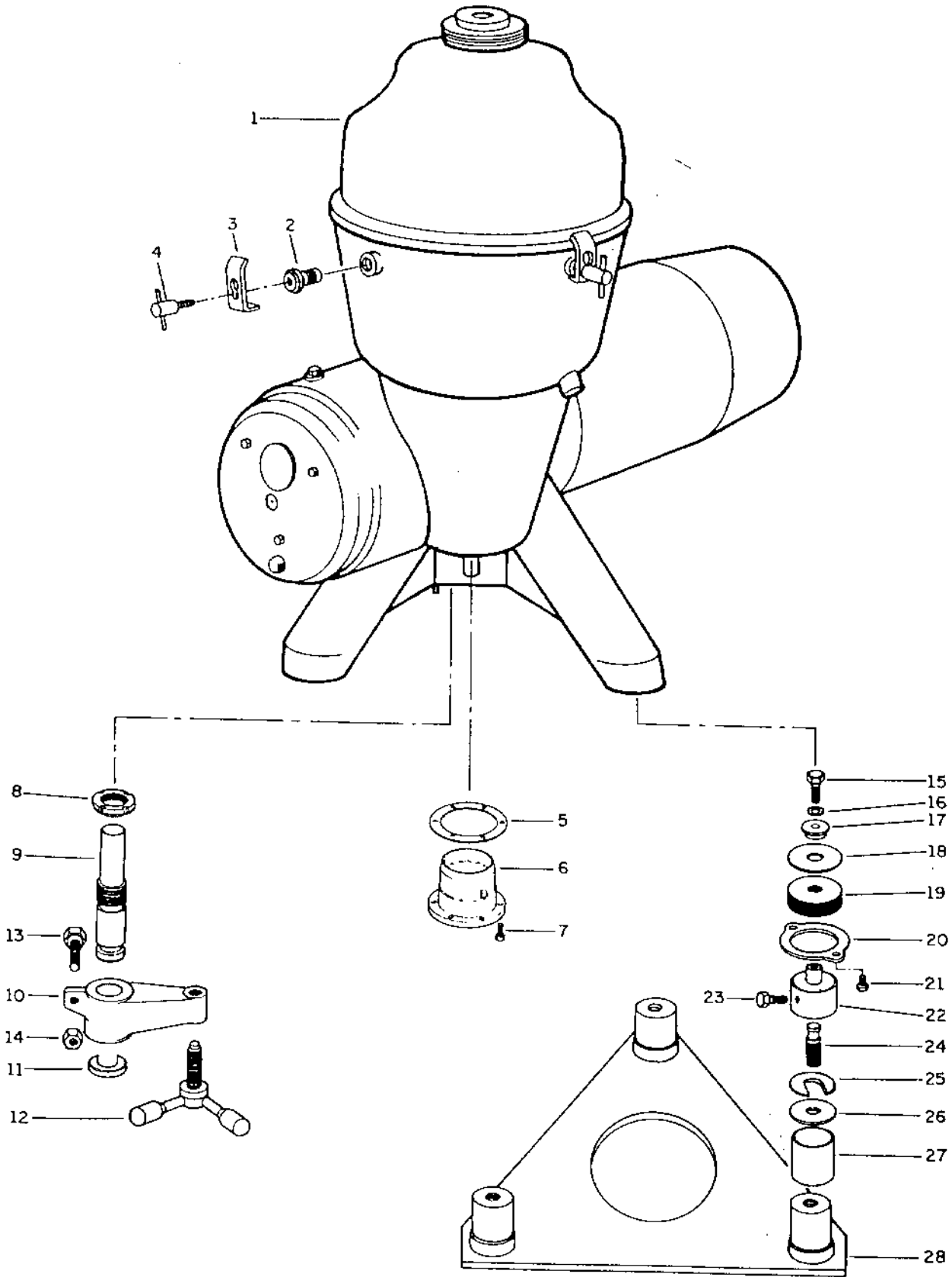

MAIN ASSEMBLY

REF.	QTY.	PART NO.	PART DESCRIPTION
1	1	8200990-80	Frame Cover
2	4	8200441-01	Bowl Lock Screw Adapter
3	4	8200444-01	Cover Clamp
4	4	8200449-80	Bowl Lock Screw
5	1	8200450-01 *	Step Bearing Gasket
6	1	8200383-01	Step Bearing
7	6	31738	Step Bearing Screw
8	1	43076Y	Lock Nut
9	1	8200443-01	Inlet Arm Shaft
10	1	8200429-01	Inlet Hinge Arm
11	1	8200440-01	Lock Washer
12	1	8200470-80	Hand Clamp Screw
13	1	8200428-01	Stop Screw
14	1	39108	Nut
15	3	39104	Frame Foot Screw
16	3	9611	Washer
17	3	8200518-01	Upper Frame Foot Washer
18	3	8200522-01	Upper Support Washer
19	3	8200525-01 *	Rubber Base Cushion
20	3	8200454-01	Lower Support Washer
21	6	8200526-01	Screw
22	3	8200521-01	Frame Foot
23	3	8200524-01	Frame Foot Stop Screw
24	3	8200519-01	Stud Bolt
25	9	8200520-01	Adjusting Washer
26	3	8200523-01	Lower Frame Foot Washer
27	3	8200516-01	Foundation Foot Sleeve
28	1	8200527-80	Foundation Plate

*Suggested spare parts inventory.

MOTOR COVER

REF.	QTY.	PART NO.	PART DESCRIPTION
1	1	34960	Motor Cover Screw
2	1	8200377-80	Motor Cover
3	1	8200142-02 *	Motor End Seal Strip
4	1	37081 *	Motor Cover Spacer
5	2	25193	Motor Bracket Screw
6	2	20550	Motor End Seal Washer
7	1	8200530-80	Motor Cover Bracket
8	2	8200529-01	Motor Stud Spacer Nut
9	1		Motor
10	2	785018-80Y	Conduit Box Seal Sleeve
11	4	39088	Conduit Box Cover Screw
12	1	8200126-01 *	Conduit Box Cover Gasket
13	1	8200125-01	Conduit Box Cover

*Suggested spare parts inventory.

42

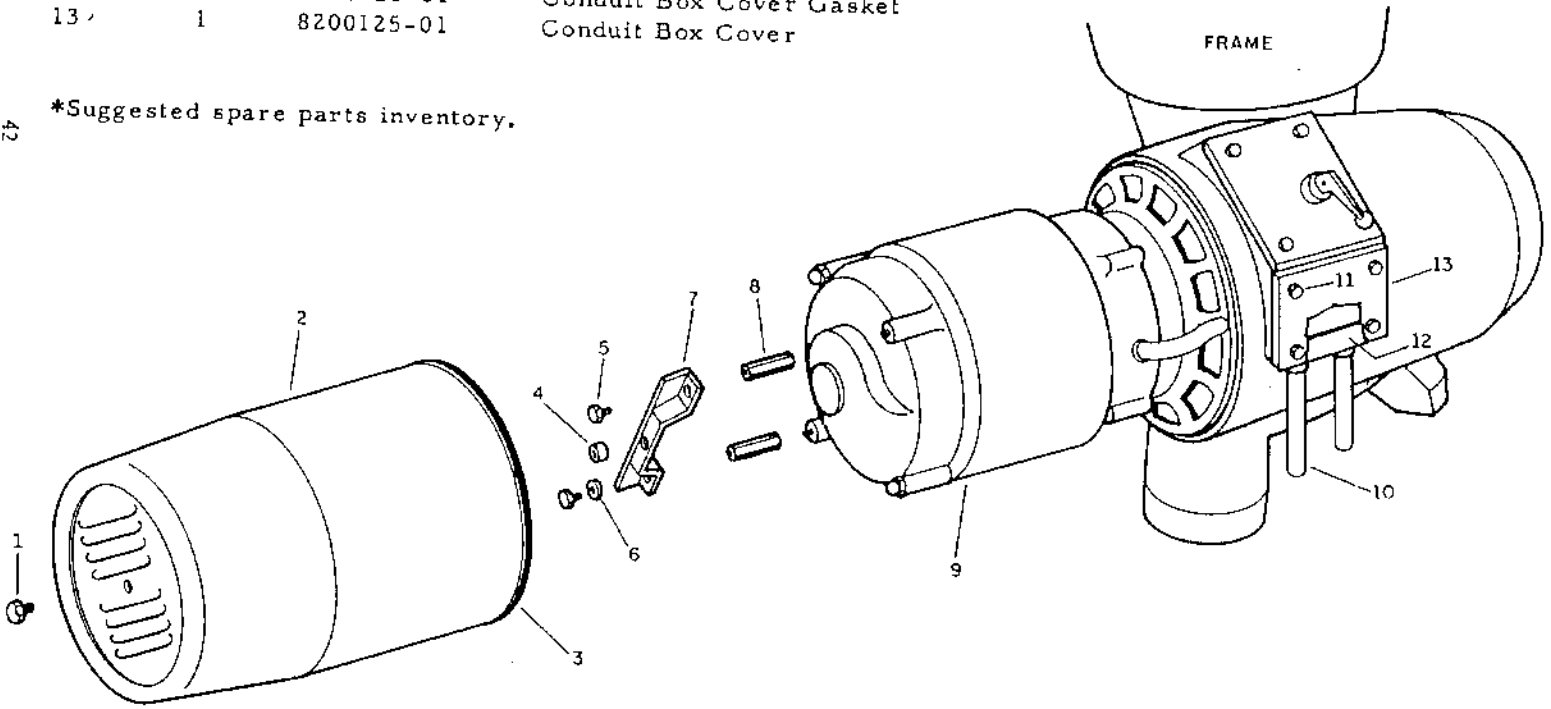

BOWL

BOWL
-540-

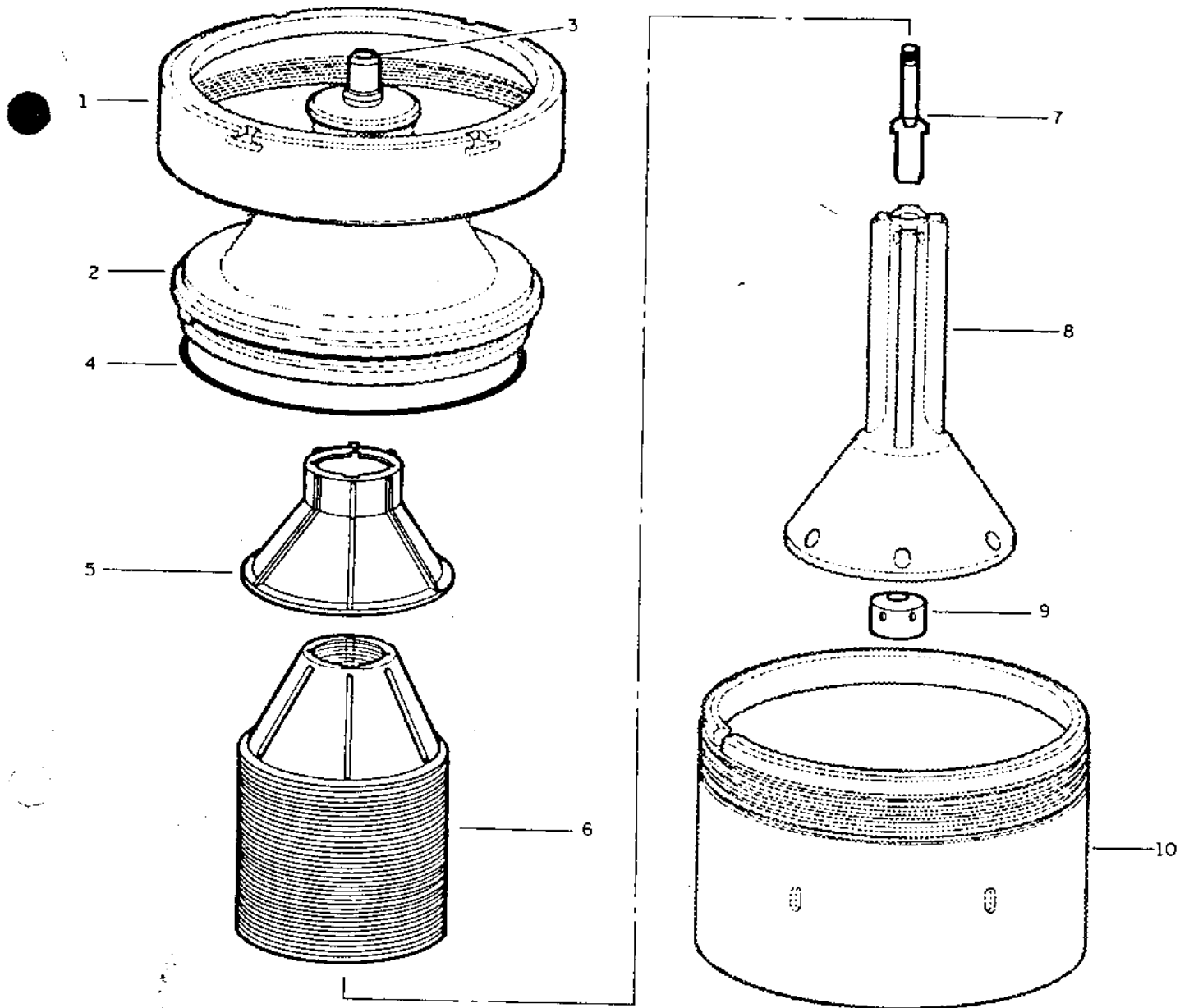

REF.	QTY.	PART NO.	PART DESCRIPTION
1	1		Coupling Ring
2	1		Bowl Top
3	1	8200337-01 *	Outlet Sleeve
4	1	8200330-02 *	Bowl Top Rubber Ring
5	1	8200427-80	Top Disc
6	93	8200472-80	Intermediate Disc (Unsoldered Caulks)
		8200472-82	Intermediate Fill-in Disc (unsoldered caulks)
	93	8200472-81	Intermediate Disc (Soldered Caulks)
		8200472-83	Intermediate Fill-in Disc (soldered caulks)
7	1	8200481-80	Anchor Stud
8	1		Disc Carrier
9	1	8200368-01	Spindle Cap Nut
10	1		Bowl Shell

*Suggested spare parts

BOWL

510-525-545-590

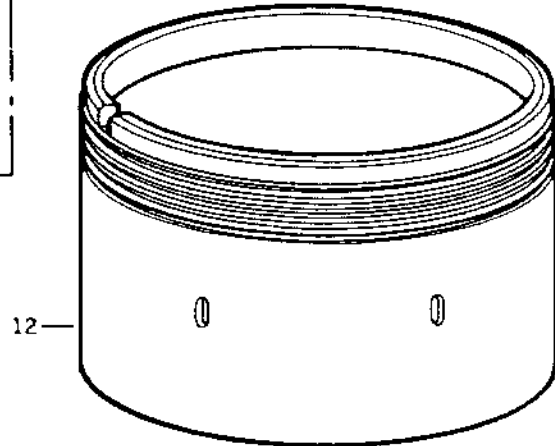
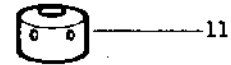
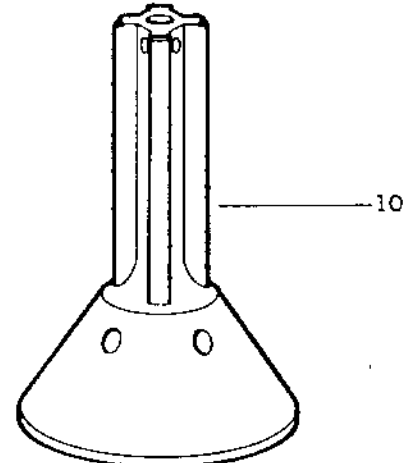
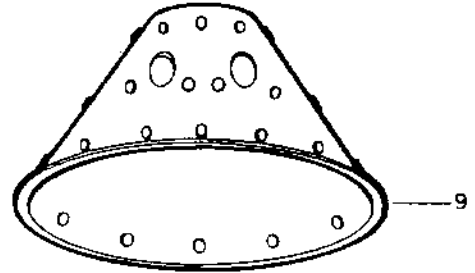
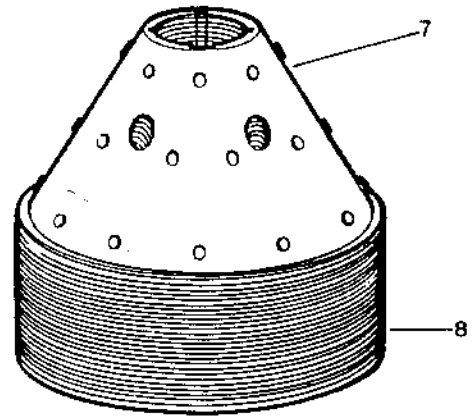
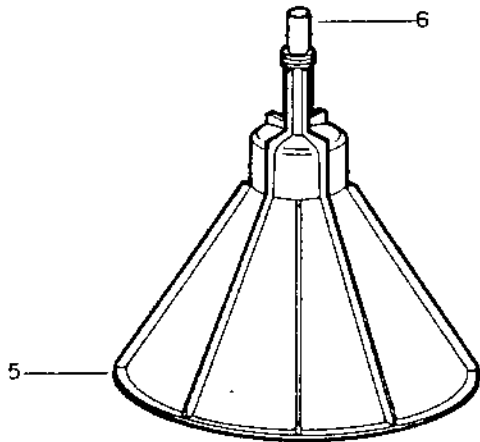
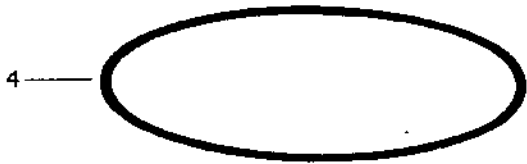
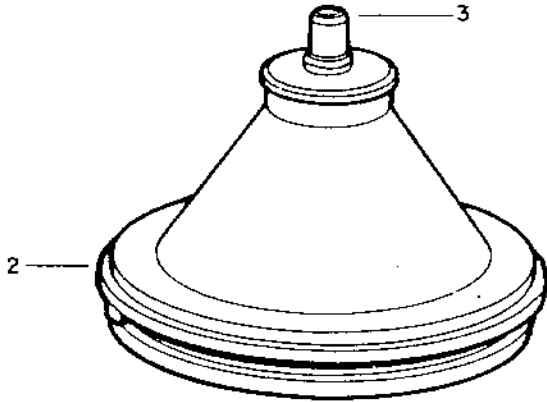
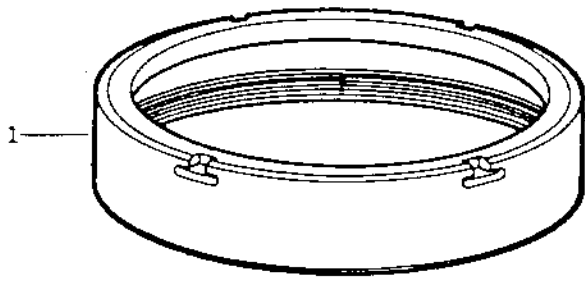

Bowl 510-525-545-590

REF.	QTY.	PART NO.	PART DESCRIPTION
1	1	-----	Coupling Ring
2	1	-----	Bowl Top
3	1	8200337-01*	Outlet Sleeve (510-525-590)
	1	8200573-01*	Outlet Sleeve (545)
4	1	8200330-02*	Bowl Top Rubber Ring
5	1	8200426-80	Top Disc (510-590)
	1	8200342-80	Top Disc (525)
	1	8200579-80	Top Disc (545)
6	1	8200347-01*	Wearing Sleeve (510-525-590)
	1	37010 *	Wearing Sleeve (545)
7	1	8200473-81	Intermediate Top Disc (510-590)
	1	8200299-81	Intermediate Top Disc (525)
	2	8200574-80	Intermediate Top Disc (545)
8	94	8200473-80	Intermediate Disc (510-590)
	135	8200299-80	Intermediate Disc (525)
	91	8200575-80	Intermediate Disc (545)
9	1	8200474-80	Bottom Disc (510-590)
	1	8200310-80	Bottom Disc (525)
	1	8200578-80	Bottom Disc (545)
10	1	-----	Disc Carrier
11	1	8200368-01	Spindle Cap Nut
12	1	-----	Bowl Shell

NOTE: Parts followed by machine numbers are used on these machines only.

*Suggested spare parts inventory.

OUTLET DEVICE

510-525-545-590

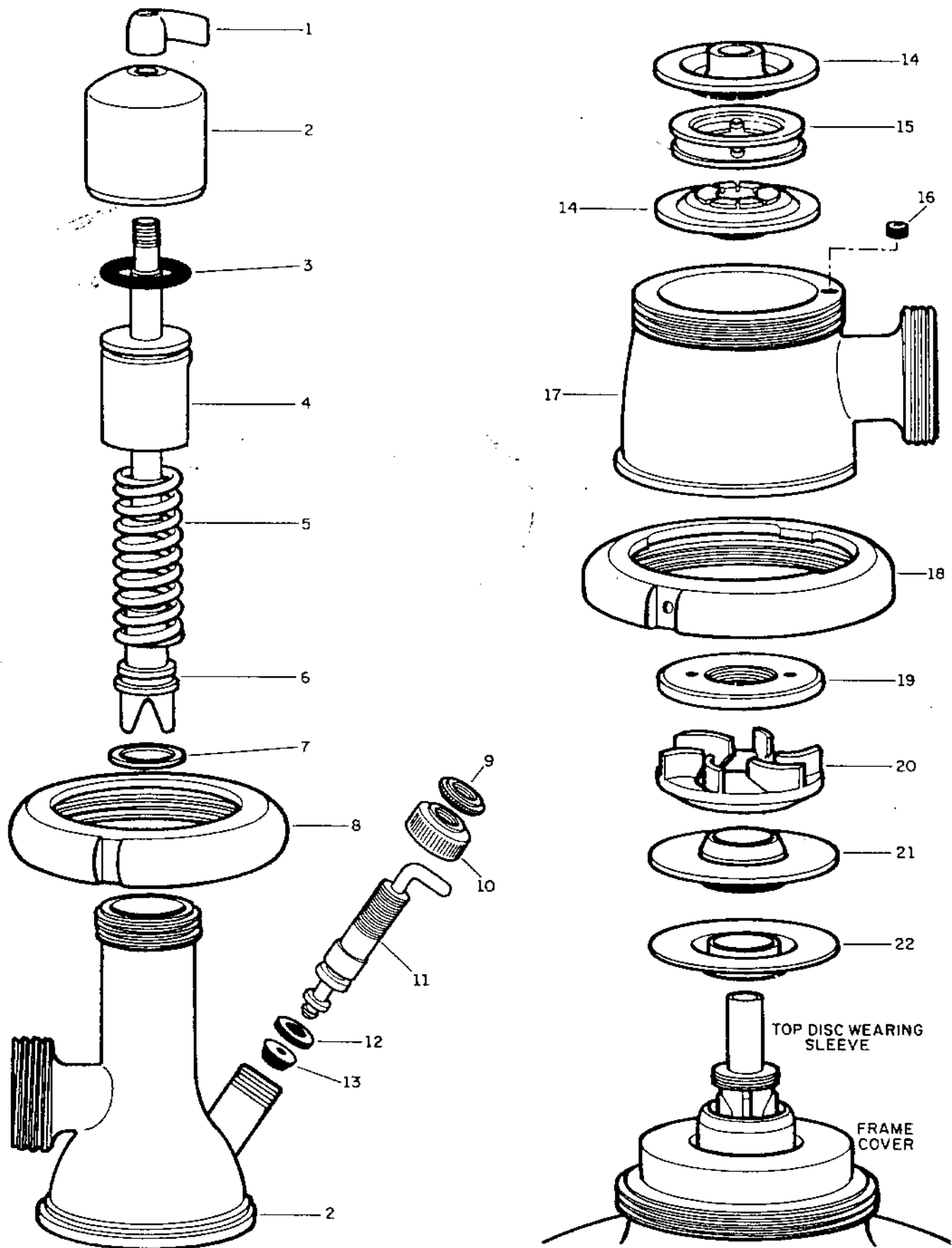

OUTLET DEVICE

510-525-545-590

REF.	QTY.	PART NO.	PART DESCRIPTION
	1	38065	Cream Control Valve (Comp.) (510-525)
	1	38707	Cream Control Valve (Comp.) (545-590)
1	1	20783	Lock Nut
2	1	38064	Body & Adjust. Nut (Comp.) (510-525)
	1	38708	Body & Adjust. Nut (Comp.) (545-590)
3	1	05555*	Rubber Ring
4	1	32856	Upper Guide
5	1	16829	Spring (510-525-545-590)
	1	16829	Spring (545-590 spare part)
6	1	32853	Control Valve
7	1	35339*	Valve Washer
8	1	32861	Coupling Ring
9	1	36336	Lock Nut (545-590)
10	1	36335	Cap Nut (545-590)
11	1	36334	Stem (545-590)
12	1	31267*	Rubber Ring (545-590)
13	1	8301124-01*	Rubber Valve (545-590)
14	2	28706*	Cream Seal (510-525-590)
	2	37399*	Cream Seal (545)
	2	37400*	Reinforcing Cup (545)
15	1	28707	Seal Holder (510-525-590)
	1	37401	Seal Holder (545)
16	1	38705*	Gasket (545-590)
17	1	8200369-80	Outlet Connection (510-525)
	1	8200367-80	Outlet Connection (545-590)
18	1	28711	Coupling Ring
19	1	8200348-01	Impeller Top (55 mm) 2-11/64" (510-525)
	1	8200348-02	Impeller Top (75 mm) 2-61/64" (545-590)
20	1	8200349-01	Impeller Bottom (55 mm) 2-11/64" (510-525)
	1	8200349-02	Impeller Bottom (75 mm) 2-61/64" (545-590)
21	1	36837*	Outlet Seal (510-525-590)
	1	36858*	Outlet Seal (545)
22	1	36838*	Reinforcing Cup (510-525-590)
	1	36859*	Reinforcing Cup (545)

NOTE: Parts followed by machine numbers are used on these machines only.

*Suggested spare parts inventory.

OUTLET DEVICE

- 540 -

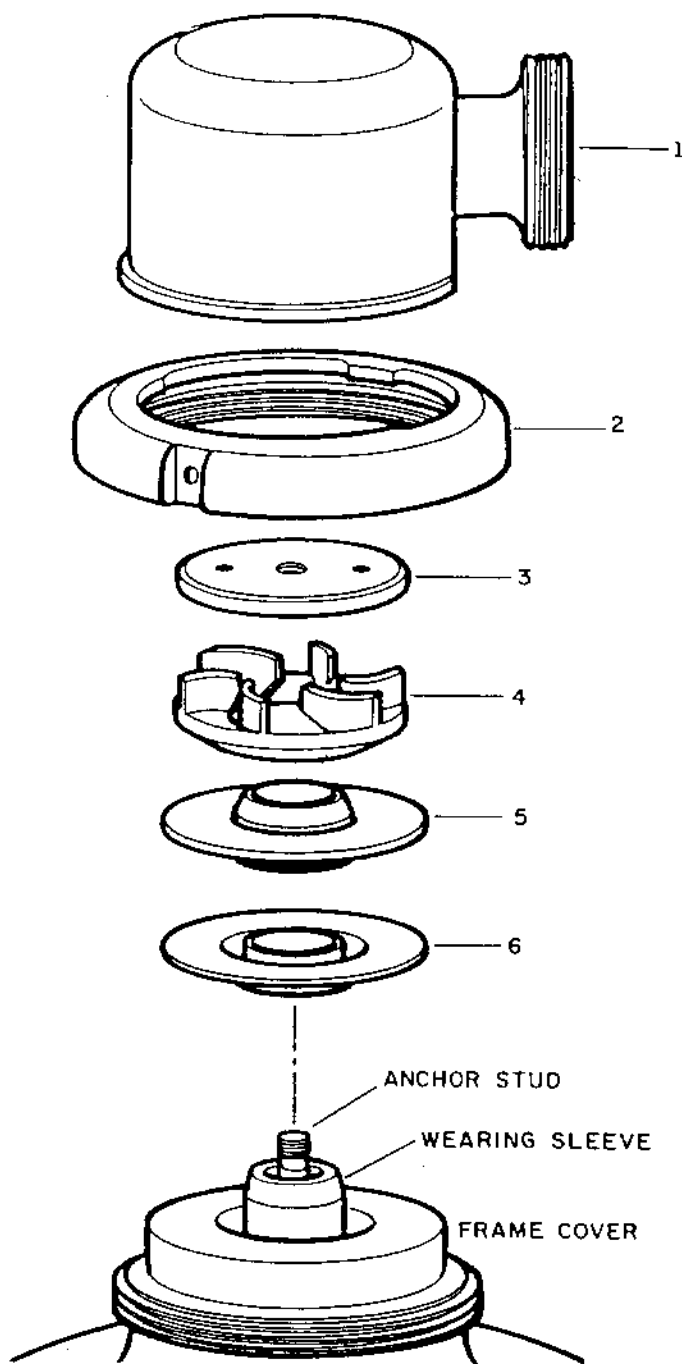

REF.	QTY.	PART NO.	PART DESCRIPTION
1	1	8200405-80	Outlet Connection
2	1	28711	Coupling Ring
3	1	8200411-01	Impeller Top
4	1	8200410-01	Impeller Bottom
5	1	36837 *	Outlet Seal
6	1	36838 *	Reinforcing Cup

*Suggested spare parts inventory.

590 INLET DEVICE

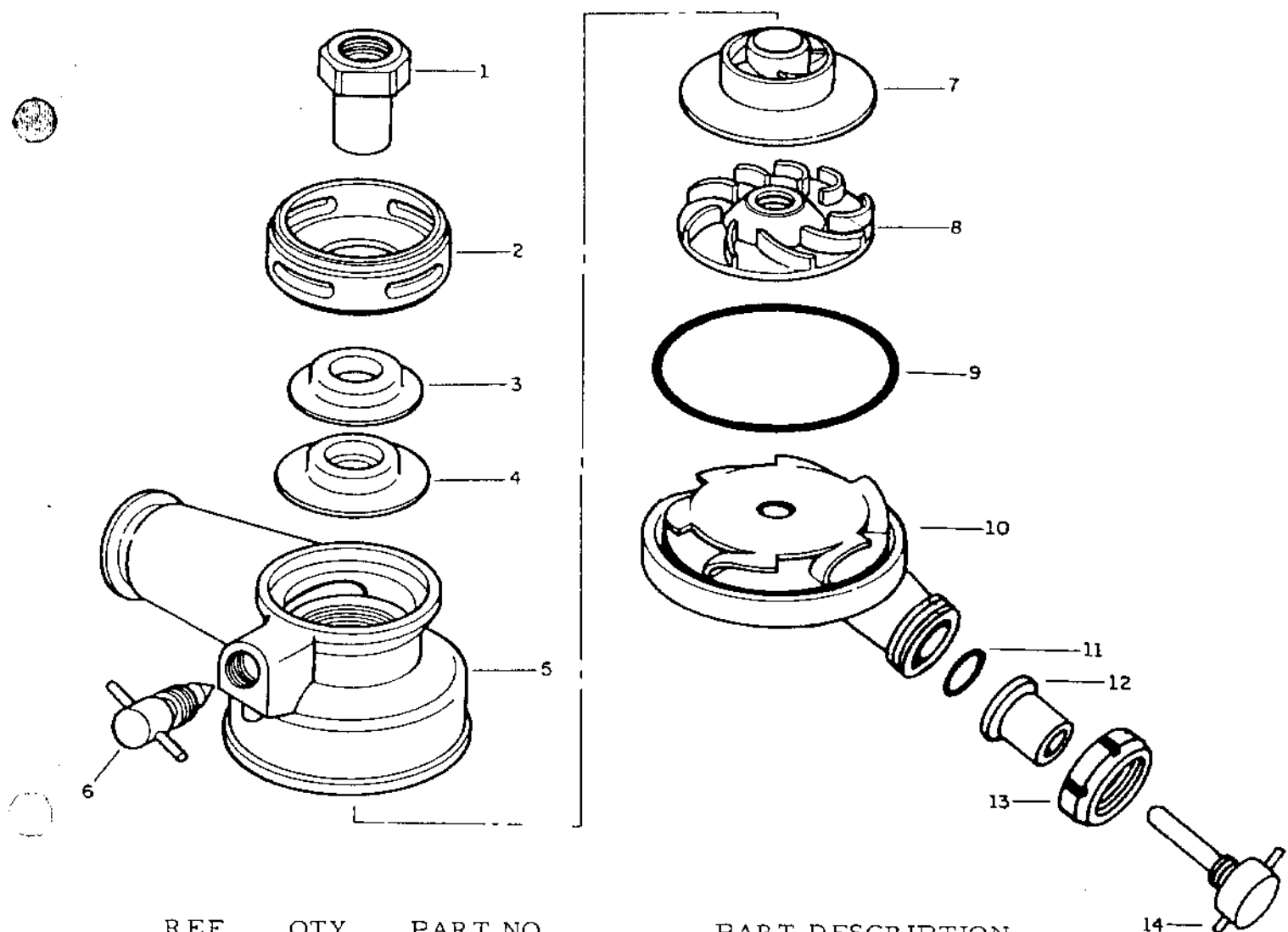

REF.	QTY.	PART NO.	PART DESCRIPTION
1	1	8200482-01*	Wearing Sleeve
2	1	8200460-01	Seal Holder
3	1	36838 *	Reinforcing Cup
4	1	36837 *	Inlet Seal
5	1	8200458-80	Pump Housing
6	1	785098-80Y*	Deaerating Screw
7	1	8200404-02	Impeller Top (120 mm) 4-47/64"
8	1	8200402-01	Impeller Bottom (120 mm) 4-47/64"
9	1	8200330-04*	Rubber Ring
10	1	43726Y	Pump Housing Cover
11	1	43733Y *	Rubber Ring
12	1	43732Y	Threaded Sleeve
13	1	190614Y	Coupling Nut
14	1	43730Y	Spindle Valve

* Suggested Spare Parts Inventory

INLET DEVICE

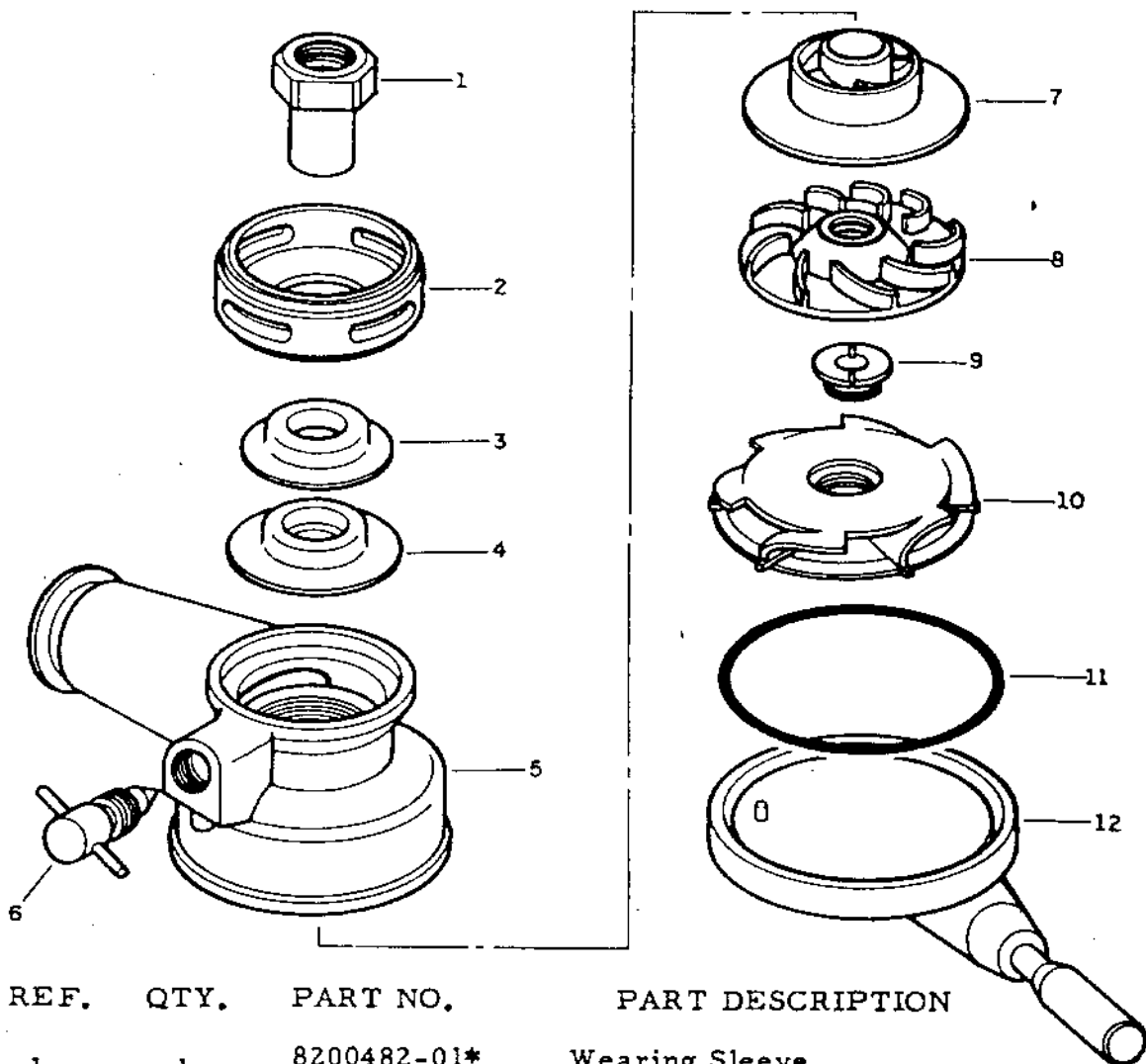

REF.	QTY.	PART NO.	PART DESCRIPTION
1	1	8200482-01*	Wearing Sleeve
2	1	8200460-01	Inlet Seal Holder
3	1	36838 *	Reinforcing Cup
4	1	36837 *	Inlet Seal
5	1	8200490-80	Pump Housing
6	1	8200487-80	Deaerating Screw
7	1	8200404-01	Impeller Top (110 mm) 4-21/64" (510-525)
	1	8200404-02	Impeller Top (120 mm) 4-47/64" (545-540)
8	1	8200403-01	Impeller Bottom (110 mm) 4-21/64" (510-525)
	1	8200402-01	Impeller Bottom (120 mm) 4-47/64" (545-540)
9	1	8200445-03	Reducer (11 mm) 7/16"
	1	8200445-07	Reducer (12.3 mm) 31/64"
	1	8200445-04	Reducer (13.5 mm) 17/32"
	1	8200445-08	Reducer (15 mm) 19/32"
	1	8200445-09	Reducer (18 mm) 23/32"
	1	8200445-06	Reducer (30 mm) 1-3/16"
10	1	8200468-80	Diffuser
11	1	8200330-04*	Rubber Ring
12	1	8200466-80	Pump Housing Cover
		8200404-03	Impeller Top - 510-525-540
		8200403-02	Impeller Bottom - 510-525-

*Suggested spare parts inventory.
 • Furnished when so ordered.

} furnished only when so ordered.

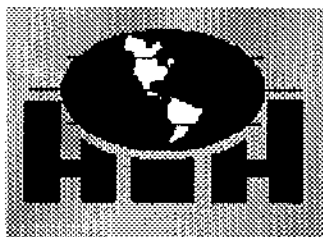

Hutchison-Hayes Separators, Inc.

This is a Spacer Page

P.O. Box 2965 ♦ Houston, Texas 77252
3520 East Belt ♦ Houston, Texas 77015
(713) 455-9600 ♦ Fax (713) 455-7753

VERTICAL DRIVE

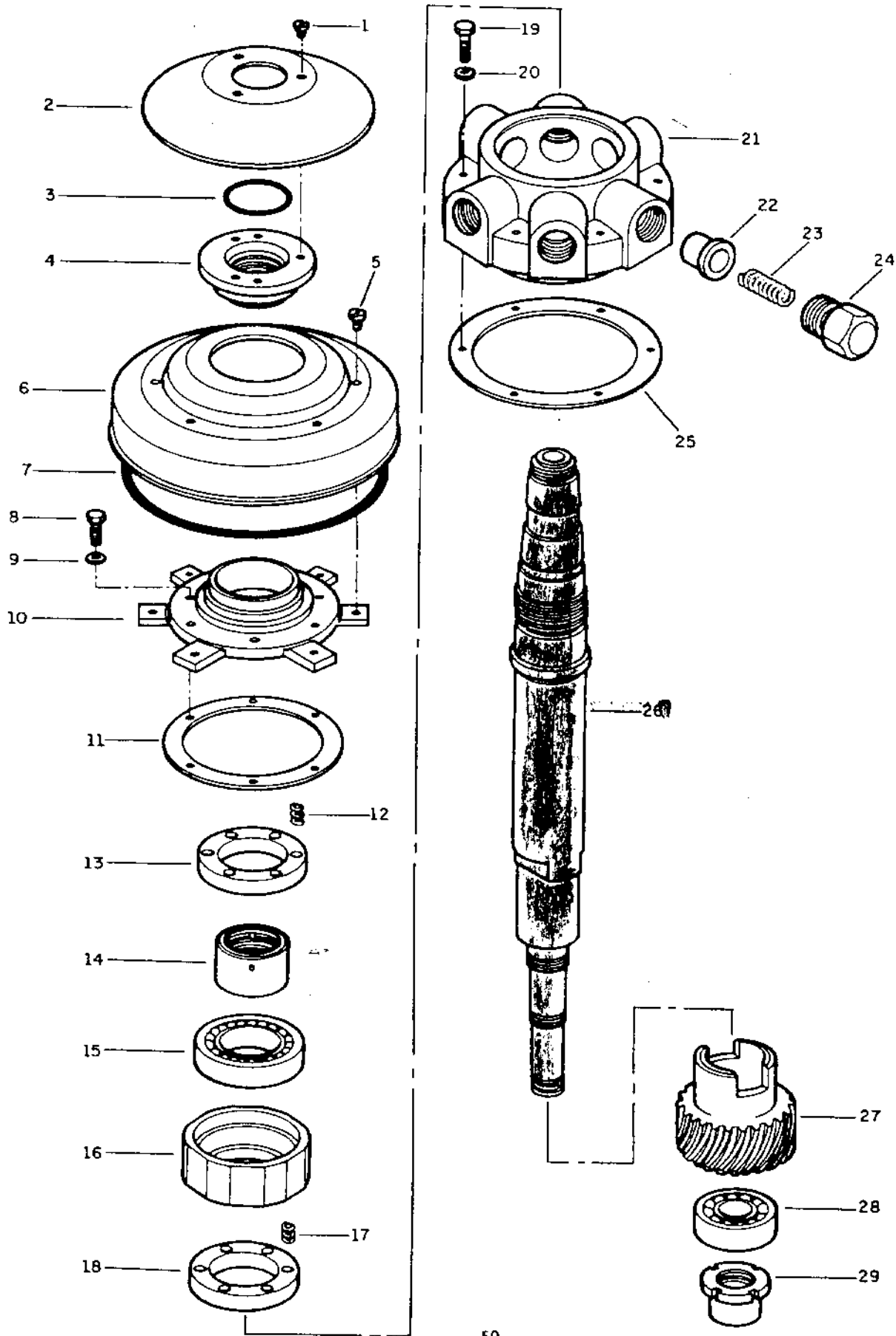

VERTICAL DRIVE

REF.	QTY.	PART NO.	PART DESCRIPTION
1	3	65203Y	Screw
2	1	8200387-01	Throw-off Plate
3	1	39270 *	Rubber Ring
4	1	39288	Protecting Cover
5	6	43712Y	Screw
6	1	8200463-80	Protecting Cap
7	1	8200330-05 *	Rubber Ring
8	6	39092	Cap Screw
9	6	6478	Washer
10	1	8200395-01	Top Bearing Plate Cover
11	1	8200396-01 *	Gasket
12	6	36446	Spring 8Q01357-01
13	1	8200388-01	Top Bearing Support Ring
6287#-14	1	8200393-01	Lock Nut
15	1	8200356-01 *	Upper Ball Bearing
16	1	8200392-01	Top Bearing Sleeve
17	6	36446	Spring
18	1	8200389-01	Spring Guide Ring
19	6	39098	Screw
20	6	9611	Washer
21	1	8200394-01	Top Bearing Plate
22	6	36452	Top Bearing Buffer
23	6	8200358-01	Top Bearing Spring
24	6	36454	Spring Housing Screw
25	1	36502 *	Gasket
26	1	8200386-01	Spindle # <u>6293</u>
27	1	8200493-01 *	Worm Quill
28	1	8200357-01 *	Lower Ball Bearing
29	1	8200462-01	Lock Nut

*Suggested spare parts inventory.

HORIZONTAL DRIVE

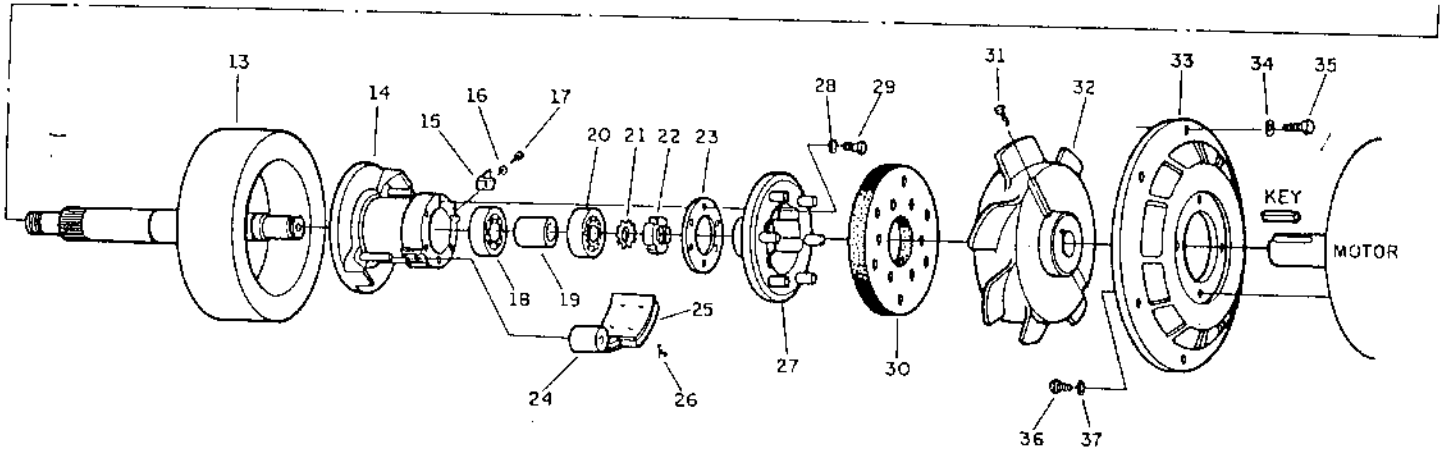
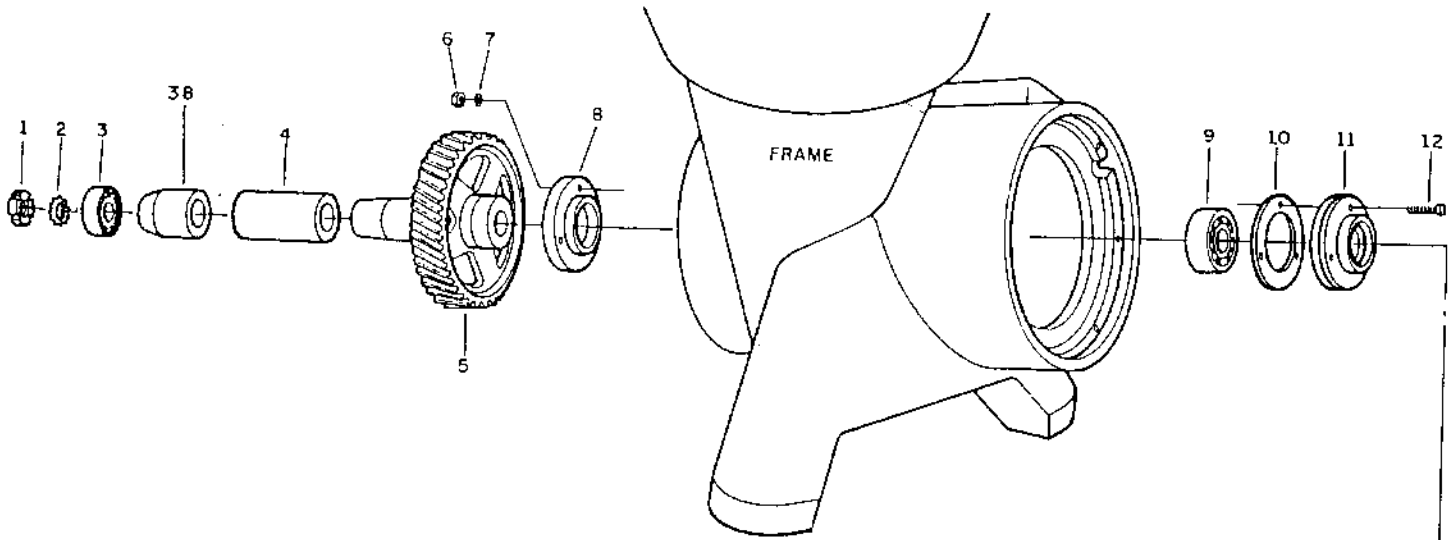

52

HORIZONTAL DRIVE

REF.	QTY.	PART NO.	PART DESCRIPTION
1	1	39418	Lock Nut
2	1	14564 *	Lock Washer
3	1	8200360-01 *	Outer Ball Bearing
4	1	8200905-01	Spacing Sleeve
5	1	8200916-01 *	Worm Wheel
6	3	32057	Nut
7	3	6478	Lock Washer
8	1	37287	Inner Cap
9	1	37424 *	Inner Ball Bearing
10	1	39446 *	Gasket
11	1	37283	Outer Cap
12	3	8200345-01	Bolt
13	1	8200400-80	Worm Wheel Shaft and Friction Clutch Housing
14	1	8200439-80	Friction Clutch Hub
15	3	37369	Stop Angle
16	3	6478	Washer
17	3	37206	Screw
18	1	30765 *	Inner Clutch Hub Ball Bearing
19	1	37210	Spacing Sleeve
20	1	30293 *	Outer Clutch Hub Ball Bearing
21	1	14564	Lock Washer
22	1	39418	Lock Nut
23	1	37207 *	Gasket
	3	37396	Friction Clutch Weight (Comp.)
24	3	37382	Friction Clutch Weight (Sep.)
		8200343-81	Friction Clutch Weight Set
25	3	37368 *	Friction Clutch Lining
26	12	37231 *	Friction Clutch Screw
27	1	8201036-80	Clutch End Coupling
28	6	6478	Washer
29	6	39092	Screw
30	1	37215 *	Rubber Cushion
31	1	39375	Set Screw
32	1	8200456-80	Motor End Coupling
33	1	8200370-01	Motor Adapter Plate
34	6	6478	Washer
35	6	22250	Screw
36	4	25001	Screw
37	4	9611	Washer
38	1	8200906-01	Spacing Sleeve

*Suggested spare parts inventory.

FRAME PARTS

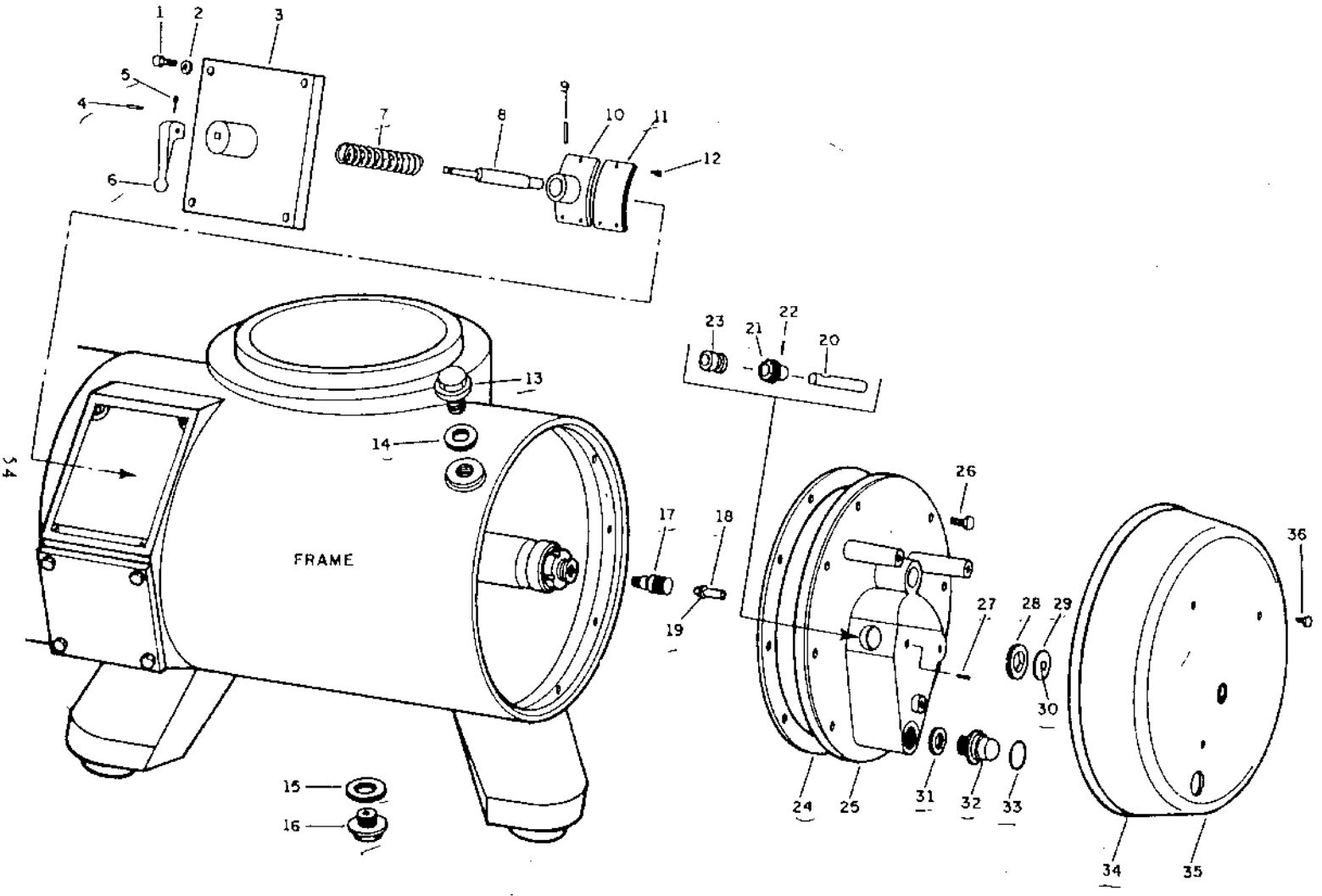

FRAME PARTS

REF.	QTY.	PART NO.	PART DESCRIPTION
1	4	38920	Screw
2	4	8200248-01	Washer
3	1	8200106-80	Brake Mounting Plate
		8200583-01	Brake Mounting Plate Gasket
4	1	39122	Handle Pin
5	1	8200252-01	Cotter Pin
6	1	8200282-01	Handle
7	1	37441	Spring
	1	8200253-80	Brake Shoe Comp.
8	1	8200254-01	Stem
9	1	39419	Pin
10	1	39357	Shoe
11	1	39358 *	Lining
12	3	37231 *	Screw
13	1	8200130-01	Oil Filler Plug
14	1	8200129-01 *	Gasket
15	1	31468 *	Gasket
16	1	8200128-01	Oil Drain Plug
17	1	11554Y *	Speed Indicator Pinion
18	1	8200115-01	Plunger
19	1	43083Y	Snap Ring
20	1	43080Y	Shaft
21	1	11553Y *	Wheel Gear
22	1	63796Y	Pin
23	1	8200104-01	Bushing
24	1	8200127-01 *	Gasket
25	1	8200176-80	Worm Wheel Housing Cover
26	8	31012	Screw
27	1	8200179-01	Set Screw
28	1	8200233-01	Lock Ring
29	1	8200139-01 *	Rubber Membrane
30	1	8200138-01	Push Button
31	1	17122 *	Gasket
32	1	43625Y	Oil Sight Glass
33	1	36781 *	Rubber Ring
34	1	8200142-01 *	Rubber Seal Strip
35	1	8200232-80	Worm Wheel Housing Hood
36	3	39089	Screw

* Suggested spare parts inventory.

TOOLS

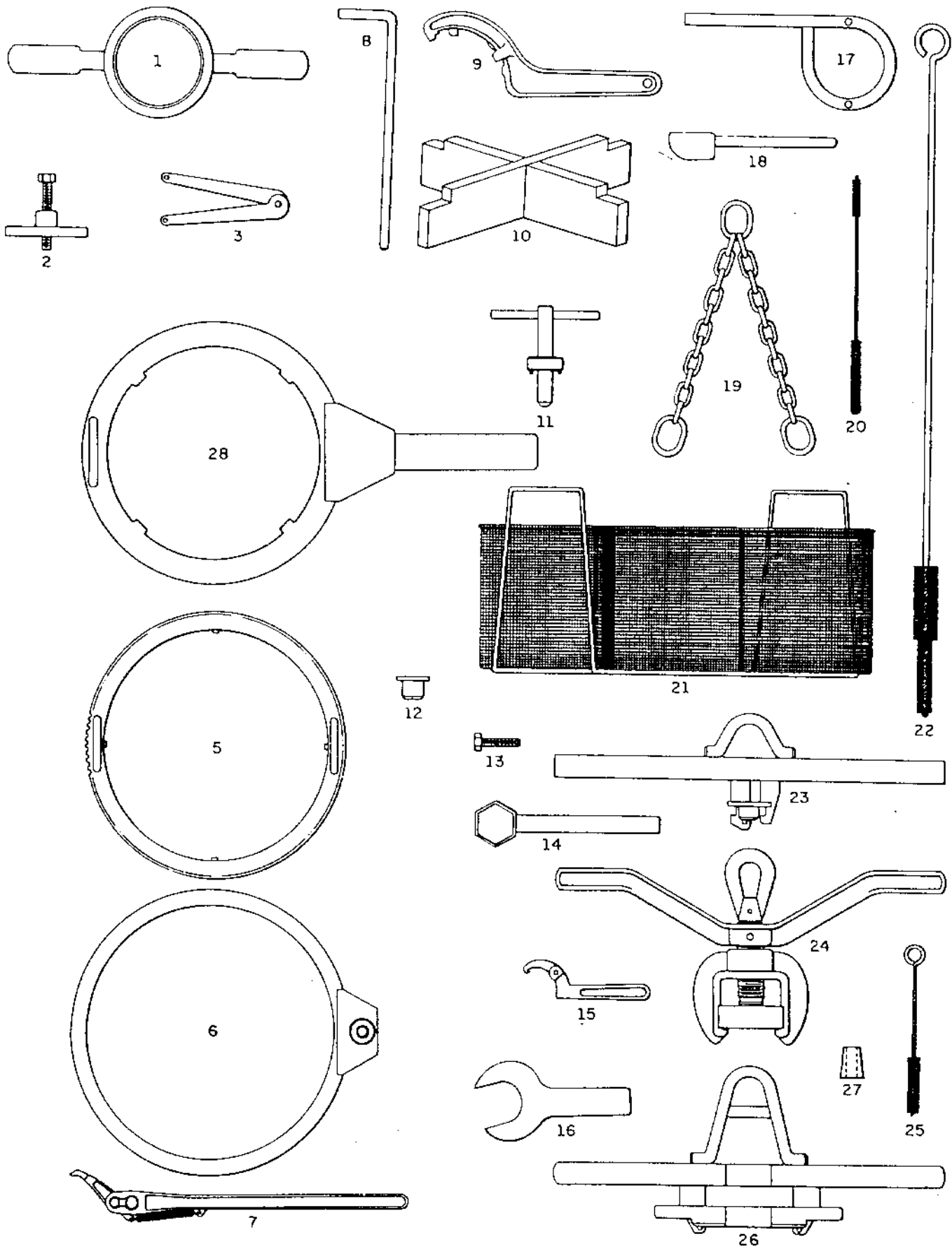

TOOLS

REF.	PART NO.	PART DESCRIPTION
1	37780	Frame Cover Lifter
2	39055	Friction Clutch Hub Extractor
3	20433	Outlet Impeller - Adjust. Spanner Wrench
	8200539-80*	Bowl Coupling Ring Ratchet Wrench (Comp.)
5	8200536-80*	Ratchet Ring for Coupling Ring Wrench
6	8200538-80*	Ratchet Wrench Support
7	8200585-80*	Lever for Ratchet Wrench
8	8200547-01	Spindle Cap Nut Wrench
9	19163	Outlet Connection Spanner Wrench
10	8200471-80	Disc Carrier Stand
11	8200459-80	Inlet Impeller Wrench
12	8200457-01	Spindle Protecting Plug
13	39533	Worm Wheel Shaft Ball Bearing Jack Screw
14	8200568-80	Inlet Wearing Sleeve Wrench
15	39483	Ball Bearing Lock Nut Hook Spanner Wrench
16	38548	Spring Housing Screw Wrench
17	38433	Top Bearing Protecting Cover Pin Spanner Wrench
18	15582	Bowl Scraper
19	31358	Sling Chain
20	02905	Standardizing Valve Cavity Brush
21	17686	Wire Basket
22	34655	Spindle Brush
23	8200513-80	Disc Carrier Lifter
24	8200498-80	Bowl Shell Lifter
25	16936	Top Disc Brush
26	8200506-80	Bowl Top Lifter
27	8200514-01	Top Disc Protecting Sleeve
	8200514-02	Top Disc Protecting Sleeve (545 only)
28	65372Y	Bowl Coupling Ring Wrench

De Laval Special Oil (orange label)

8701027-80	5 gallon
8701028-80	30 gal. drum

De Laval Stainless Steel Thread Lubricant

36325	1 Container (115 oz.)
36326	1 Squeeze Bottle
36282	1 Cap - Sq. Bottle

*When Specially Ordered.